

DESPRED



Entry system for pre-terminated cables

Splittable cable gland with locknut

- ▶ Patented cable entry system
- ▶ Frame screws in AISI304 with Black Dacromet finishing
- ▶ Up to IP66
- ▶ Strain relief according to EN 62444
- ▶ Sturdy construction IK10

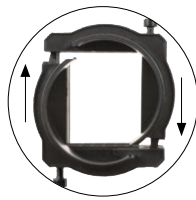

The DESPRED series are splittable cable glands for metric threads.

The 63 model can be used with small, multiple and large inserts for cables from 2 to 34mm in diameter. With multiple inserts it is possible to accommodate up to 16 cables. Future cable size changes can also be easily accommodated using various inserts.

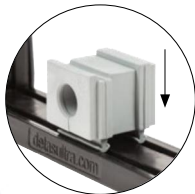

Technical data





Material: PP+GF

Flammability: self-extinguishing acc. to UL94-V0



Temperature: -40°C... +155°C (static)

Features: halogen and silicone free

Related products

-  Insert SPG
-  Insert SPP and SPP K
-  Insert SPP 2x
-  Insert SPP 4x

Hydraulic punch driver HY360

Model	Code	Some possible configurations	Pcs /pack
DESPRED 25	1731050025		10
DESPRED 32	1731050032		10
DESPRED 63	1731050063		10

Upon request: DDM SUB-D9	1731052032	Special size M32 for SUB-D9	10
			

Dimensions [mm]

DESPRED 25

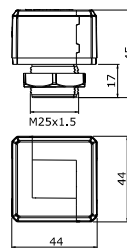

DESPRED 32

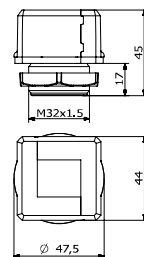

DESPRED 63

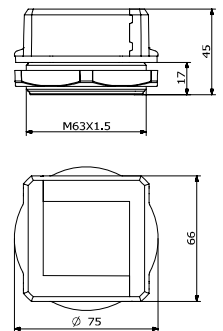



 UV ISO 4892-2A	 RoHS COMPLIANT	 CAD	 UL US pending	up to IP66	up to NEMA 4X	 PP+GF	IK10	 UL94-V0	 -40 +155 °C
---	---	--	--	----------------------	-----------------------------	---	-------------	---	---

Entry system for pre-terminated cables



DESPRED 90

Model	Code	Some possible configurations	Pcs /pack
DESPRED 90-50	1731050250	  	10



Splittable cable gland and locknut with 90° entry

- ▶ 90° cable entry system
- ▶ Fixing without screws
- ▶ Strain relief according to EN 62444
- ▶ IP54
- ▶ Sturdy construction IK10

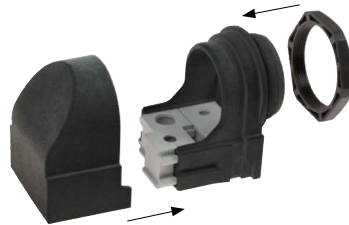

The DESPRED 90 series are splittable cable glands for metric threads with 90° entry.

The 90-50 model can be used with small, multiple and large inserts for cables from 2 to 34mm in diameter. With multiple inserts it is possible to accommodate up to 16 cables. Future cable size changes can also be easily accommodated using various inserts.



1

Technical data





Material: PP+GF

Flammability: self-extinguishing acc. to UL94-V0

Temperature: -40°C... +155°C (static)

Features: halogen and silicone free

Related products

-  Insert SPG
-  Insert SPP and SPP K
-  Insert SPP 2x
-  Insert SPP 4x

Hydraulic punch driver HY360 and related punches



Dimensions [mm]

DESPRED 90-50

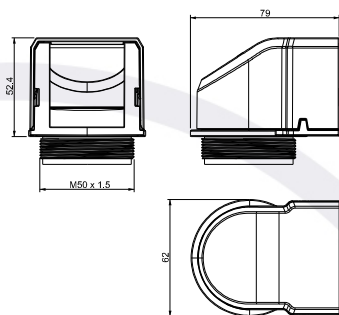

Via Treponti, 29 - 25086 Rezzato BS - Italy - Tel. +39 030 2594120 - info@detasultra.com - www.detasultra.com

© Detas SpA - ISO9001/ISO14001 certified company

